

Uniden

App Cam Pano Series

Quick Start Guide

What's in the Box

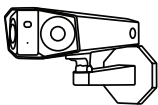

App Cam Pano



Antenna



Waterproof Lid

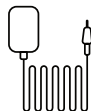

Power Adapter

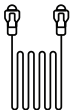

1M
Ethernet Cable

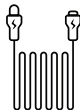

Power
Extension Cable

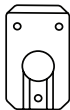

Mounting Plate

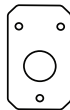

Mounting Hole
Template



Quick Start Guide

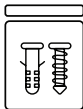

Pack of Screws



Screw Driver

General Introduction

Antenna

Daylight Sensor

Mic

Lens

Spotlights

Infrared Light

Mounting Bracket

Weatherproof Lid

Ethernet Port

Power Port

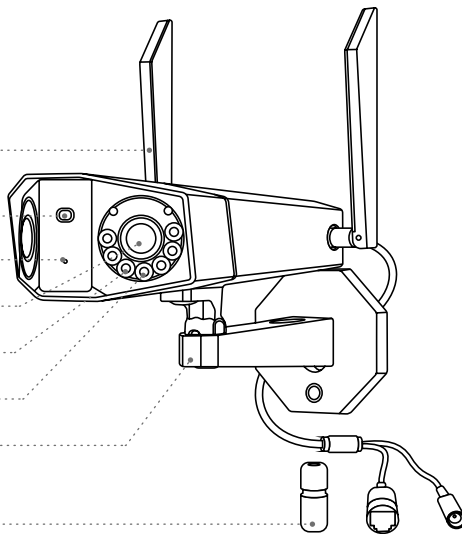

Micro SD Card Slot

*Reset Button

Use a pin to press.

Speaker

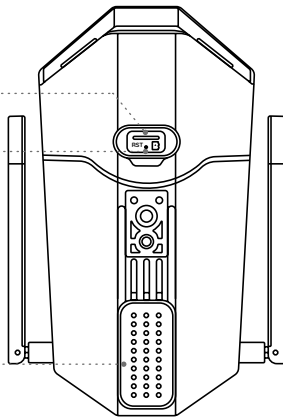

***Note:**

Reset: Press and hold the Reset button for 5 seconds or until you hear a beep while the camera is powered on to return your camera to factory default settings

Powering the Camera

For initial setup, please power on the camera with the power adapter and also connect the camera to your router LAN port with an Ethernet cable, and then follow the steps to set up your camera. Please make sure your camera and your phone are on the same network.

1. Connect the camera to a LAN port on your router with an Ethernet cable for initial setup.
2. Use the power adapter to power on the camera.

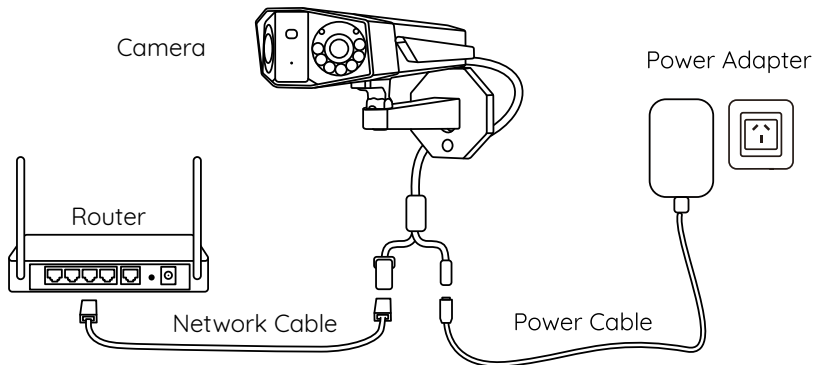

Install Uniden Solo App

There are two ways to get the Uniden Solo App:

- Search “Uniden Solo” in App Store (for iOS), download and install the app.
- Search “Uniden Solo” in Google Play (for Android), download and install the app.

1. Please click the “+” button in the top right corner to add the camera.

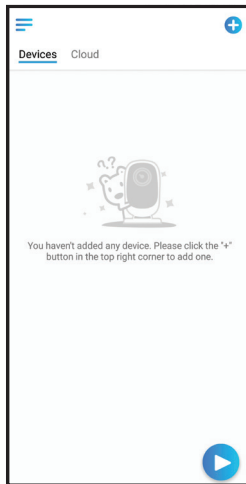

If you've opened the Add Device Automatically option on the Settings page, you can tap the device on the Device List page and skip to step 4 directly.

If you don't enable that option, you can tap the Add icon on the upright corner, and scan the QR code on the camera to add this device.

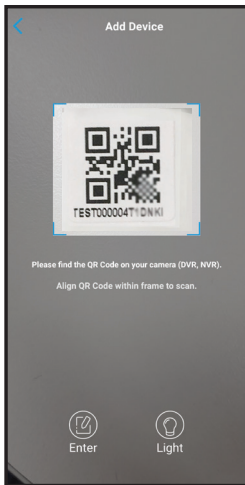

2. Scan the QR code on the body of the camera.

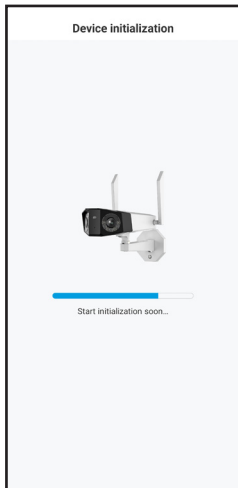

3. Camera starts initialisation setup.

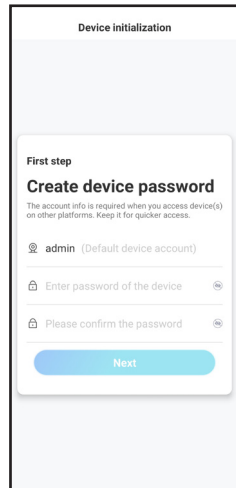

4. Create the login password for the camera and tap Next.

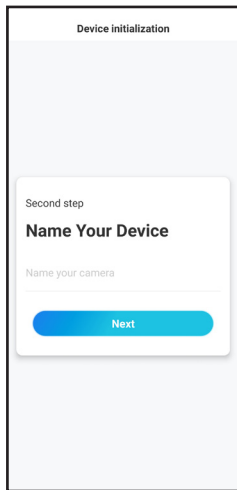

5. Name the camera and tap Next.

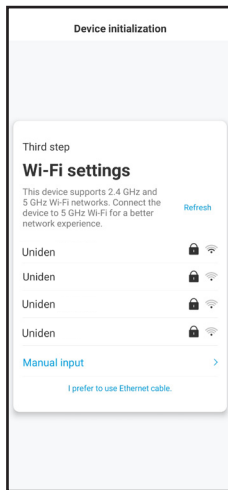

6. Choose the WiFi network you want to join.

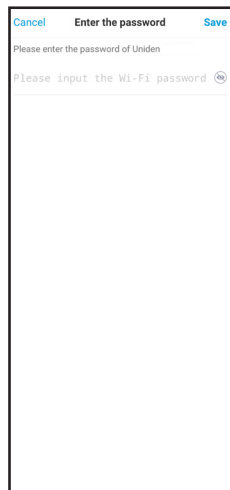

7. Enter the password of the WiFi network, and then tap Save to save the configuration.

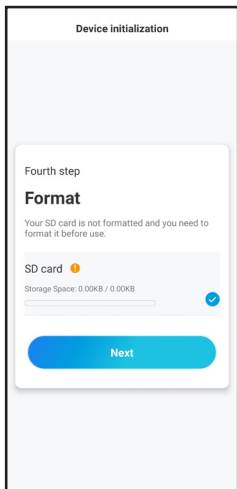

8. Format the SD card inserted in the camera (optional) and then tap Next to format the SD Card.

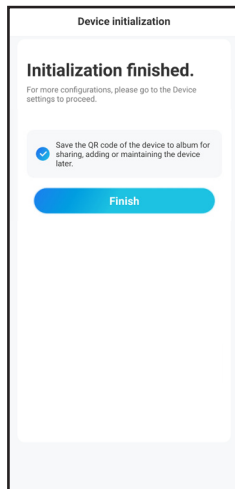

9. Tap Finish to complete the setup.

Device Menu

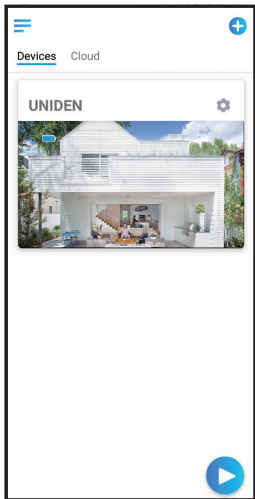

Menu



Add New Device



Device Settings



Access Live View

WiFi Connection

Here is the steps on how to connect the camera to a WiFi network. If the WiFi was setup in the initialisation stage, remove the Ethernet cable wait for a moment for the camera to reconnect to the network.

Note: If this device cannot connect to the WiFi after you remove the Ethernet cable, connect the camera to the router again with the Ethernet cable and check the network settings.

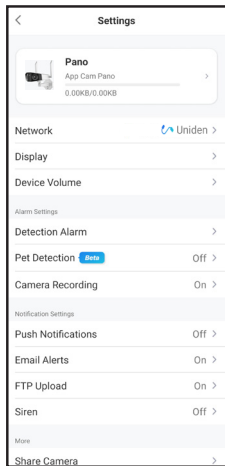

Log in to the camera, and enter the Device Settings > Network interface.

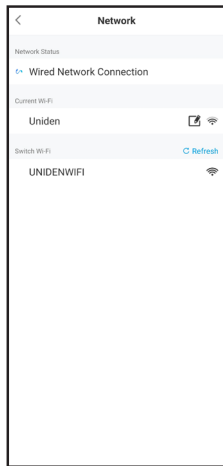

Select the Network, input the password, and click Save.

Remove the Ethernet cable between the camera and the router and wait for a moment. The camera will connect to the Wi-Fi.

Mount the Camera

Installation Tips

- Do not face the camera towards any light sources.
- Do not point the camera towards a glass window. Or, it may result in poor image quality because of the window glare by infrared LEDs, ambient lights or status lights.
- Do not place the camera in a shaded area and point it towards a well-lit area. Or, it may result in poor image quality. To ensure best image quality, the lighting condition for both the camera and the capture object shall be the same.
- To ensure better image quality, it's recommended to clean the lens with a soft cloth from time to time.
- Make sure the power ports are not directly exposed to water or moisture and not blocked by dirt or other elements.
- With IP weatherproof ratings, the camera can work properly under conditions like rain and snow. However, it doesn't mean the camera can work underwater.
- Do not install the camera at places where rain and snow can hit the lens directly.
- Try to keep the left lens level with the right lens.

How to Mount the Camera to the Wall

1. Drill holes in accordance with the mounting template and use the drywall anchors included in the package if needed.
2. Secure the mounting plate to the wall with the upper two screws and hang the camera on it.
3. Then lock the camera in position with the lower screw.

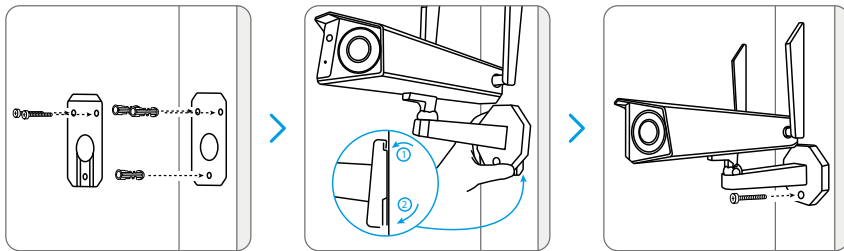

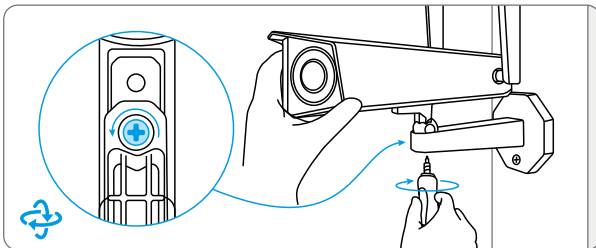

To get the best field of view, loosen the adjustment screw on security mount and turn the camera.

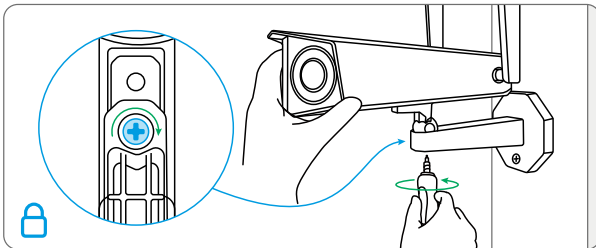

Stiffen the adjustment screw to lock the camera.

How to Mount the Camera to the Ceiling

1. Drill holes in accordance with the mounting template and use the drywall anchors included in the package if needed.
2. Secure the mounting plate to the wall with the upper two screws and hang the camera on it.
3. Then lock the camera in position with the lower screw.

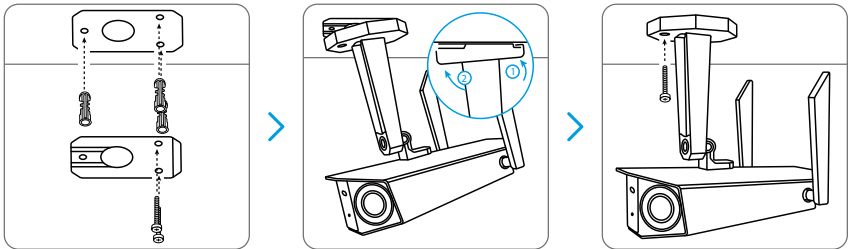

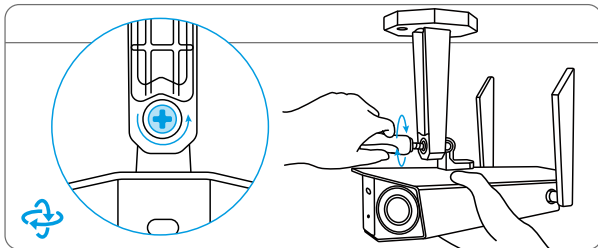

To get the best field of view, loosen the adjustment screw on security mount and turn the camera.

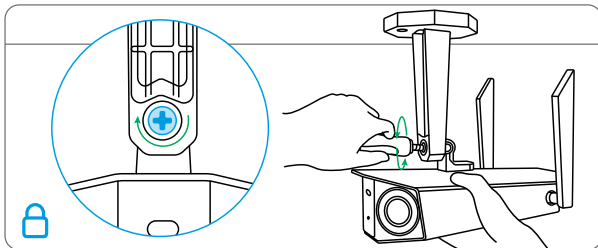

Stiffen the adjustment screw to lock the camera.

Troubleshooting

Camera is not powering on

If your camera is not powering on, please try the following solutions:

- Plug the camera into a different outlet and see if it works.
- Power on the camera with another working 12V 2A DC adapter and see if it works.

Failed to Connect to WiFi During Initial Setup Process

If the camera fails to connect to WiFi, please try the following solutions:

- Ensure that you have entered the correct WiFi password.
- Put the camera closer to your router to ensure a strong WiFi signal.
- Change the encryption method of the WiFi network to WPA2-PSK/WPA-PSK (safer encryption) on your router interface.
- Change your WiFi SSID or password and make sure that SSID is within 31 characters and password is within 64 characters.

Picture is not Clear

If the picture from the camera is not clear, please try the following solutions:

- Check the camera lens for dirt, dust or spiderwebs, please clean the lens with a soft, clean cloth.
- Point the camera to a well-lit area, the lighting condition will affect the picture quality a lot.
- Restore the camera to factory settings and check out again.

Specification

	Model	App Cam Pano
Video	Image Sensor	1/3" CMOS Image Sensor
	Video Resolution	4608 x 1728 (8.0Megapixel) 20 fps
	Video Compression	H.264/H.265
	Viewing Angle	Horizontal: 170° / Vertical: 60°
	Night Vision	Up to 30 Meters
	Spotlight Colour	6500K
	Spotlight Brightness	560 Lumens
	PIR Detecting Angle	Horizontal: 100°
	Night Vision	Up to 10 Meters
	Alert	Motion Detection/Person Detection/Vehicle Detection
	Record Mode	Motion/Schedule Recording
	Audio	Two-way Audio
	Frame Rate	Main Stream: 4fps~20fps / Sub Stream: 4fps~20fps
	Bit Rate	Main Stream: 3072Kbps~10240Kbps / Sub Stream:256Kbps~2048Kbps
WiFi	WiFi	IEEE 802.11a/b/g/n 2.4GHz/5GHz
	Wireless Security	WPA-PSK/WPA2-PSK
Ethernet	Ethernet Port	10M/100Mbps RJ45

Power	DC Power	DC 12.0V/2A, <15W
Storage	SD Card	Supports up to 256GB micro SD card, min class 10
Size & Weight	Size	195 x 103 x 56 mm
	Weight	700g
Other Parameters	Temperature	Operating Temperature : -10°C~+55°C
	Humidity	Operating Humidity: 20% ~ 85%
	Waterproof Level	IP66 Weatherproof

WARRANTY

Uniden App Cam Pano SERIES

Important:

Satisfactory evidence of the original purchase is required for warranty service. Please refer to our Uniden website for any details or warranty durations offered in addition to those contained below.

Warrantor:

The warrantor is Uniden Australia Pty Limited ABN 58 001 865 498 (“Uniden Aust”).

Terms of Warranty: Uniden Aust warrants to the original retail purchaser only that the Uniden App Cam Pano Series (“the Product”), will be free from defects in materials and craftsmanship for the duration of the warranty period, subject to the limitations and exclusions set out below.

Warranty Period: This warranty to the original retail purchaser is only valid in the original country of purchase for a Product first purchased either in Australia or New Zealand and will expire, as indicated below, from the date of original retail sale.

Product	2 Year
Accessories	6 Month

If a warranty claim is made, this warranty will not apply if the Product is found by Uniden to be:

- A. Damaged or not maintained in a reasonable manner or as recommended in the relevant Owner’s Manual;
- B. Modified, altered or used as part of any conversion kits, subassemblies or any configurations not sold by Uniden Aust;
- C. Improperly installed contrary to instructions contained in the relevant Owner’s Manual
- D. Repaired by someone other than an authorized Uniden Repair Agent in relation to a defect or malfunction covered by this warranty; or
- E. Used in conjunction with any equipment, parts or a system not manufactured by Uniden.

Parts Covered: This warranty covers the Product and included accessories.

User-generated Data: This warranty does not cover any claimed loss of or damage to user-generated data (including but without limitation phone numbers, addresses and images) that may be stored on your Product.

Statement of Remedy: If the Product is found not to conform to this warranty as stated above, the Warrantor, at its discretion, will either repair the defect or replace the Product without any charge for parts or service. This warranty does not include any reimbursement or payment of any consequential damages claimed to arise from a Product's failure to comply with the warranty.

Our goods come with guarantees that cannot be excluded under the Australian Consumer Law. You are entitled to a replacement or refund for a major failure and for compensation for any other reasonably foreseeable loss or damage. You are also entitled to have the goods repaired or replaced if the goods fail to be of acceptable quality and the failure does not amount to a major failure.

This warranty is in addition to and sits alongside your rights under either the COMPETITION AND CONSUMER ACT 2010 (Australia) or the CONSUMER GUARANTEES ACT (New Zealand) as the case may be, none of which can be excluded.

Procedure for Obtaining Warranty Service: Depending on the country in which the Product was first purchased, if you believe that your Product does not conform with this warranty, you should deliver the Product, together with satisfactory evidence of your original purchase (such as a legible copy of the sales docket) to Uniden. Please refer to the Uniden website for address details. You should contact Uniden regarding any compensation that may be payable for your expenses incurred in making a warranty claim. Prior to delivery, we recommend that you make a backup copy of any phone numbers, images or other data stored on your Product, in case it is lost or damaged during warranty service.

UNIDEN AUSTRALIA PTY LTD

Phone number: 1300 366 895

Email address: custservice@uniden.com.au

THANK YOU FOR BUYING A UNIDEN PRODUCT

© 2022 Uniden Australia Pty Limited v1.0
Printed in PRC